

EVERYTHING 4 LESS

ENJOY YOUR BOOKS

PLEASE VISIT OUR STORE FOR EVEN MORE GREAT STUFF!

WWW.EVERYTHING4LESSSTORE.COM

COPYRIGHT NOTICE

ALL MATERIALS INCLUDING CD/DVD AND PDF FILES ARE COPYRIGHTED

WWW.EVERYTHING4LESSSTORE.COM VON WALTHOUR PRODUCTIONS AND MAY NOT BE REPRODUCED, COPIED OR RESOLD UNDER ANY CIRCUMSTANCES. YOU MAY HOWEVER MAKE A COPY FOR YOUR OWN PERSONAL BACKUP. MATERIALS ARE FOR PERSONAL USE ONLY.

IF YOU PURCHASED THIS FROM ANYWHERE BUT FROM US PLEASE NOTIFY US IMMEDIATELY SO THAT WE MAY CHECK IF YOU PURCHASED FROM AN AUTHORIZED RESELLER SO WE CAN LET YOU KNOW IF YOU NEED TO RETURN FOR FULL REFUND FROM AN UNAUTHORIZED SELLER.

THANKS AGAIN AND PLEASE TAKE THE TIME TO VISIT OUR STORE.

ATTENTION! EVERYTHING ON SALE NOW!!



HOT SALE!

\$15

LPS-151/152

dc tracking power supply



instruction manual

LEADER
FOR PROFESSIONALS WHO KNOW
THE DIFFERENCE

LPS-151/152
DC TRACKING POWER SUPPLY
TABLE OF CONTENTS

1. DESCRIPTION	1
2. FEATURES	1
3. SPECIFICATIONS	1
4. CONTROLS AND CONNECTORS	2
5. OPERATING PRECAUTIONS	4
5.1 Input Power	4
5.2 Output Terminals	4
5.3 General	4
5.4 Environmental Considerations	4
6. POWER SUPPLY OPERATION	4
6.1 +6V Range Source	4
6.1.1 Operation at a Constant Voltage	4
6.1.2 Operation Using Current Limiting	4
6.2 $\pm 25V$ Range Sources	4
6.2.1 Fixed Tracking Mode, Constant Voltage Operation	4
6.2.2 Variable Tracking Ratio Mode, Constant Voltage Operation	5
6.2.3 Operation Using Current Limiting	5
6.2.4 Voltage Settings Above 25V, Constant Voltage Operation	5
6.2.5 Voltage Settings Above 25V, with Current Limiting	5
7. CALIBRATION PROCEDURES	5
7.1 Preparation	5
7.2 Adjustment of Meter Zero with Power On	6
7.3 Adjustment of the Voltmeter with Power On	6
7.4 Ammeter Adjustments	6
7.5 Connections for Other AC Line Voltages	7
8. PARTS LISTS	8
8.1 LPS-151 Parts List	8
8.2 LPS-152 Parts List	10
9. BLOCK DIAGRAMS, PC BOARDS, AND SCHEMATICS	12

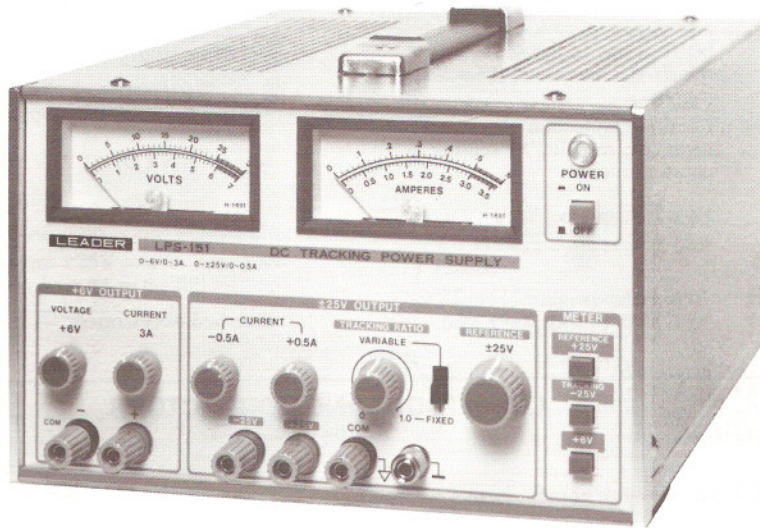

Figure 1-1. DC Tracking Power Supply

1. DESCRIPTION

The LPS-151/152 DC Tracking Power Supplies each provide three regulated voltage sources, covering the 0 to 6V, 0 to 25V and 0 to -25V ranges. The +25V and -25V range sources can also be used in a voltage tracking mode. These power supplies are equipped with a built-in voltmeter and ammeter so that the output conditions for each section of the supply can be monitored individually.

2. FEATURES

1. The +25V and -25V sources can be used in a voltage ratio tracking mode.
2. A source of 50V may be obtained by connecting the load across the +25V and -25V terminals.
3. Voltage and current settings are made via front panel controls and can be monitored on the built-in voltmeter and ammeter.

3. SPECIFICATIONS

Voltage and Current Ranges

Model	Output Voltage Range	Output Current Range
LPS-151	0 to 6Vdc	0 to 3A
	0 to 25Vdc	0 to 0.5A
	0 to -25Vdc	0 to 0.5A
LPS-152	0 to 6Vdc	0 to 5A
	0 to 25Vdc	0 to 1A
	0 to -25Vdc	0 to 1A

Ripple:	Less than 3mV _{p-p}
Line Regulation (output stability):	Less than 3mV plus 0.01% of the input change for a 10% change of line voltage.
Load Regulation:	Less than 3 mV plus 0.01% of the load value from no load to full load.

Tracking Voltage: In the ratio tracking mode, the -25V source tracks the +25V source by an adjustable ratio of 50 to 100%.

Voltmeter: 0 to 7 volts and 0 to 30 volts on a dual scale. The meter range and polarity are determined by pressing the appropriate METER switch.

Voltmeter Accuracy: 5% of the full scale reading.

Ammeter: LPS-151: 0 to 0.6 amperes and 0 to 3.5 amperes on a dual scale.
LPS-152: 0 to 1.2 amperes and 0 to 6 amperes on a dual scale.
The meter range and polarity are determined by pressing the appropriate METER switch.

Ammeter Accuracy:	5% of the full scale reading.	Operating Temperature Range	0° to 35°C (32° to 95°F)
Insulation Voltage:	1500 Vac applied for one minute between one of the ac input terminals and the case of the power supply.	Operating Humidity Range	30 to 85% (non-condensing)
Circuit Protection:	Overload protection circuit with automatic resetting by sensing a constant current.	Storage Temperature Range	-20 to +70°C (-4 to 158°F)
Power Consumption:	LPS-151: approx. 120VA LPS-152: approx. 220VA	Size (W x H x D)	LPS-151: 8½ x 5¼ x 13 in. 215 x 132 x 332 mm. LPS-152: 8½ x 5¼ x 14⅛ in. 215 x 132 x 360 mm.
Heat Sink Temperature Range:	At room temperature (23 to 25°C) 85°C (185°F) with 100% load.	Weight:	LPS-151: 13½ lbs.; 6.1 kg LPS-152: 15¾ lbs.; 7.5 kg
		Supplied Accessories:	Instruction Manual

4. CONTROLS AND CONNECTORS

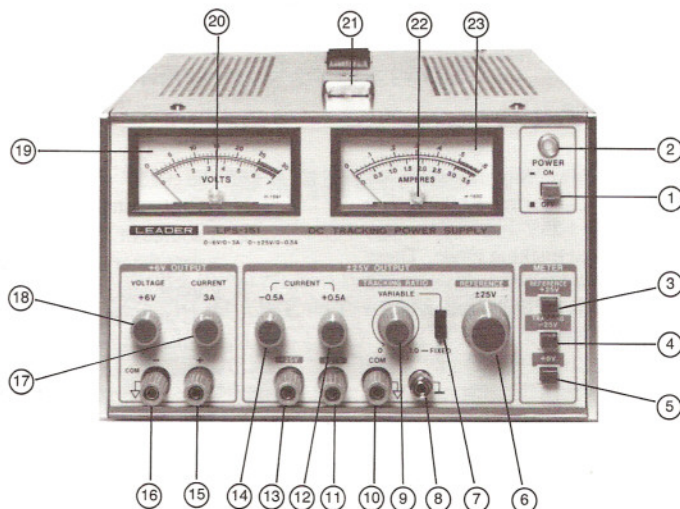

Figure 4-1. Front Panel

Front Panel. Refer to Figure 4-1.

- | | |
|--|---|
| <p>① POWER Switch Press to turn on power. Press again to release button and turn off power.</p> <p>② Pilot lamp Lights when power is on.</p> <p>③ METER selector switches These switches assign the voltmeter and ammeter to one of the ranges. (3) is for the +25V source, (4) is for the -25V source, and (5) is for the +6V source.</p> <p>④ METER selector switch</p> <p>⑤ METER selector switch</p> <p>⑥ REFERENCE/±25V Control This provides output voltage level setting for the +25V and -25V range sources.</p> | <p>⑦ TRACKING RATIO Selector Switch In the FIXED position, the REFERENCE/±25V control (6) sets both 25V sources to the same magnitude but opposite polarity. In the VARIABLE position, ratio tracking of the -25V source using the +25V source as a reference is possible.</p> <p>⑧ Case ground terminal This terminal is connected directly to the case</p> <p>⑨ TRACKING RATIO Control This control determines the tracking ratio for the -25V source. When the TRACKING RATIO selector switch is in FIXED, this control is disabled.</p> |
|--|---|

- ⑩ COM terminal This is the common point for the +25V and -25V sources. This terminal is internally connected to COM terminal (16) for the 6V source.
- ⑪ +25V Source output terminal
- ⑫ CURRENT control
LPS-151: +0.5A
LPS-152: +1A This sets the output current limit for the +25V source. It is adjustable from 0A to the full load current rating.
- ⑬ -25V Source output terminal
- ⑭ CURRENT control
LPS-151: -0.5A
LPS-152: -1A This sets the output current limit for the -25V source. It is adjustable from 0A to the full load current rating.
- ⑮ 6V Source output terminal
- ⑯ COM terminal Common terminal for the 6V source. This terminal is internally connected to COM terminal (10) for the +25V and -25V sources.
- ⑰ CURRENT control
LPS-151: 3A
LPS-152: 5A This sets the output current limit for the 6V source. It is adjustable from 0A to the full load current rating.
- ⑱ VOLTAGE +6V control This sets the output voltage for the +6V source.
- ⑲ Voltmeter Gives voltage indication in the +25V and +6V ranges, selected by one of the METER (3), (4), and (5) buttons.
- ⑳ Voltmeter Zero adjust
- ㉑ Handle
- ㉒ Ammeter Zero adjust
- ㉓ Ammeter Gives current indication in the $\pm 25V$ and +6V ranges, selected by one of the METER mode (3), (4), and (5) buttons.

Rear Panel. Refer to to Figure 4-2.

- ㉔ AC Cord Power cord, 3-wire grounded
- ㉕ Fuse
LPS-151:
120V operation, 2A slow blow
240V operation, 1A slow blow
LPS-152:
120V operation, 3A slow blow
240V operation, 1.5A slow blow
- ㉖ Heat sink Dissipates heat to ensure proper power supply operation.

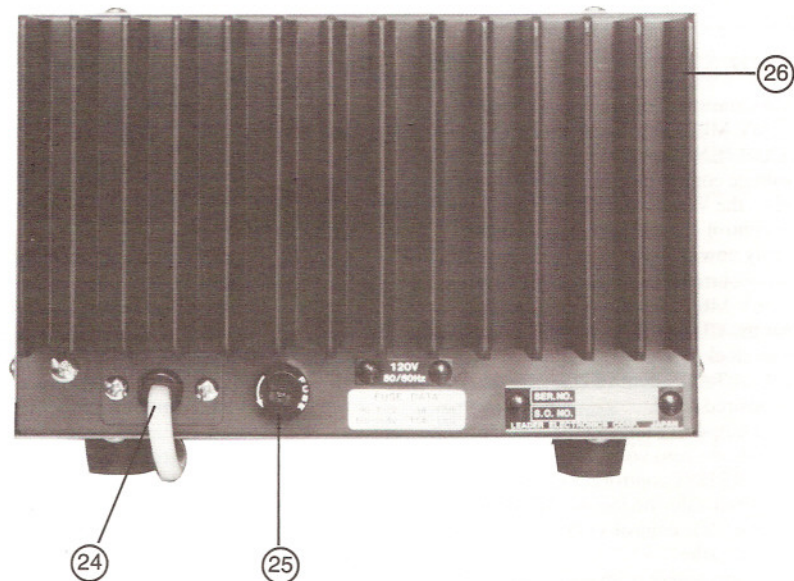

Figure 4-2. Rear Panel

5. OPERATING PRECAUTIONS

5.1 INPUT POWER

Line voltage should be within $\pm 10\%$ of rated voltage (100V, 120V, 200V or 234V). Units shipped within the U.S. are set for 120Vac. Permissible operating range is 108 to 132 Vac. To adapt the unit to other voltages, see Section 7.5.

5.2 OUTPUT TERMINALS

1. Connecting COM terminal (10) or (16) to case ground terminal (8) renders both COM terminals grounded to the case.
2. In the case where a voltage output in the 25 to 50 volt range is obtained by a connection across the +25V and -25V terminals, ensure that both COM terminals are ungrounded.
3. In all cases, ensure that connections to the output terminals of the power supply are made with lead wire of a sufficient rating for the current being drawn from the supply.

5.3 GENERAL

1. The red zones on the voltmeter and ammeter indicate out of specification readings. Do not operate the power supply under conditions that cause red zone readings.

2. When replacing the fuse, ensure that the AC line cord has been removed from the power source.
3. When long lead wires are used to connect a load to the power supply, currents may be induced in the leads by stray electromagnetic fields. These currents may cause oscillation in the power supply. In order to maintain the power supply stable, connect an appropriately valued electrolytic capacitor at the load. Also note that the use of long lead wires tends to increase voltage regulation.

5.4 ENVIRONMENTAL CONSIDERATIONS

1. Avoid operation of the power supply under the following conditions:
 - a. Dusty environments
 - b. High humidity
 - c. Poor ventilation
 - d. Near other power sources
 - e. Exposed to direct sunlight
2. The ambient temperature for power supply operation should be in the range from 0° to 35°C (32° to 95°F).
3. Ensure that the power supply is kept well ventilated. This includes keeping the area around the supply clear, especially the heat sink section.

6. POWER SUPPLY OPERATION

For all operation, the power cord must be connected to an AC power source of the proper voltage and frequency. The unit is turned on by pushing the POWER button (1) in. The green LED (2) should light when the unit is turned on.

6.1 +6V RANGE SOURCE

1. Operation at a Constant Voltage
 - a. Press the +6V METER selector button (5).
 - b. Turn the CURRENT control (17) fully clockwise.
 - c. Use the voltage control (18) to set the voltage to the desired level on the VOLTMETER (19). (Clockwise rotation of the control causes voltage to increase.)
 - d. The load may now be connected to the supply.
2. Operation using current limiting.
 - a. Press the +6V METER selector button (5).
 - b. Ensure that the CURRENT control (17) is turned to its fully counterclockwise position.
 - c. Using the VOLTAGE control (18), set the output voltage to the desired level.
 - d. Short circuit output terminals (15) and (16). The voltmeter will indicate zero volts.
 - e. Using the CURRENT control (17), set the current limiting to the desired value on the AMMETER (23). Rotating the CURRENT control (17) clockwise raises the current limit setpoint.
 - f. Remove the short circuit from output terminals (15) and (16).
 - g. The load may now be connected to the supply.

6.2 $\pm 25V$ RANGE SOURCES

The $\pm 25V$ sources may be operated in one of two modes. In the FIXED TRACKING mode, the output of the -25V source will track the setting of the +25V source in a 1:1 ratio. In the VARIABLE TRACKING RATIO mode, the output of the -25V source tracks the output of the +25V source by a ratio that is adjusted by the user.

- 6.2.1. FIXED TRACKING mode, constant voltage operation
 - a. Push the REFERENCE +25V METER selector button (3).
 - b. Ensure that the TRACKING RATIO selector switch (7) is in the FIXED position.
 - c. Turn CURRENT controls (12) and (14) to their fully clockwise positions.
 - d. Turn the REFERENCE $\pm 25V$ control (6) to the desired positive voltage level. This will also cause the -25V source to be set at the same voltage with the opposite polarity.

To confirm this, press the TRACKING METER -25V selector button (4). It should indicate the same voltage magnitude as the +25V range reading, within 1.5%. After the comparison, press the REFERENCE +25V METER selector button (3) again.
 - e. The load may now be connected to the supply.

- 6.2.2. Variable Tracking Ratio Mode, Constant Voltage Operation.
- Push the +25V METER selector button (3).
 - Ensure that the TRACKING RATIO selector switch (7) is in the VARIABLE position.
 - Turn the CURRENT controls (12) and (14) to their fully clockwise positions.
 - Turn the REFERENCE/+25V control (6) to the desired positive voltage.
 - Push the TRACKING -25V METER selector button (4).
 - Using the TRACKING RATIO control (9), set the -25V source to the desired negative voltage.

After the TRACKING RATIO control (9) has been set, turning the REFERENCE/+25V control (6) will cause the -25V source to change its voltage with respect to the +25V source by the established ratio.

- Press the REFERENCE +25V METER selector button (3).
 - The load may now be connected to the supply.
- 6.2.3. Operation Using Current Limiting
- Set the CURRENT controls (12) and (14) to their fully counterclockwise positions.
 - Set the $\pm 25V$ sources to the desired voltage by using one of the procedures above. Disregard the step involving turning the current controls fully clockwise.
 - Ensure that the REFERENCE +25V METER selector button (3) is pressed in.
 - Short circuit the COM and +25V terminals (10) and (11). The voltmeter will indicate zero volts.
 - Set the +0.5A (+1A for the LPS-152) CURRENT control (12) to the desired level of current limiting as indicated on the AMMETER (23). Rotating the CURRENT control (12) clockwise raises the current limit setpoint.
 - Remove the short circuit from the COM and +25V terminals (10) and (11).
 - Press the TRACKING -25V METER selector button (4).
 - Short circuit the COM and -25V terminals (10) and (13). The voltmeter will indicate zero volts.
 - Set the -0.5A (-1A for the LPS-152) CURRENT control (14) to the level of current limiting desired as indicated on the AMMETER (23). Rotating the CURRENT control (14) clockwise raises the current limit setpoint.

- Remove the short circuit from the COM and -25V terminals (10) and (13).
- Press the REFERENCE +25V METER selector button (3).

1. The load may now be connected to the supply.

6.2.4. Voltage Settings Above 25V, Constant Voltage Operation.

Used together, the $\pm 25V$ sources will produce a maximum output of 50V. However, in this mode the 6V output may not be used.

- Press the REFERENCE +25V METER selector button (3).
- Set CURRENT controls (12) and (14) to their fully clockwise position.
- Ensure that the TRACKING RATIO selector switch (7) is in the FIXED position.
- Turn the REFERENCE/+25V control (6) such the the voltmeter (18) indicates one-half of the desired voltage value. Remember that the voltmeter will only indicate one-half of the voltage value between the $\pm 25V$ output terminals (11) and (13).
- The load may now be connected to the supply. The maximum current available at 50V is 0.5A (1.0A with the LPS-152).

6.2.5. Voltage Settings Above 25V with Current Limiting.

- Set the CURRENT controls (12) and (14) to their fully counterclockwise positions.
- Set the +25V sources for above 25V operation by using the procedure above. Disregard the step involving turning the current controls fully clockwise.
- Ensure that the REFERENCE +25V METER selector button (3) is pressed in.
- Short circuit the +25V and -25V terminals (11) and (13). The voltmeter will indicate zero volts.
- Set the +0.5A (+1A for the LPS-152) CURRENT control (12) to the desired level of current limiting as indicated on the AMMETER (23). Rotating the CURRENT control (12) clockwise raises the current limit setpoint.
- Remove the short circuit from the +25V and -25V terminals (11) and (13).
- The load may now be connected to the supply.

7. CALIBRATION PROCEDURES

The following instructions detail the calibration of the meters and voltage outputs for the LPS-151/152 power supply. Also included are transformer tap changing directions so that the power supply may be used with a line voltage other than 120Vac.

7.1 PREPARATION

- Adjustment of Meter Mechanical Zero.
 - Turn the power supply off and allow one minute for all capacitors to discharge.
 - On the voltmeter, turn the zero adjust screw (20) so that the pointer indicates exactly zero.
 - When the pointer is at zero, rotate the screw a small amount in the opposite direction to the direction it was last turned in step b to relieve movement tension.

- On the ammeter, turn the zero adjust screw (22) so that the pointer indicates exactly zero.
- When the pointer is at zero, rotate the screw a small amount in the opposite direction to the direction it was last turned in step d to relieve meter movement tension.

2. Initial Control Settings

Set the front panel controls to the positions indicated.

VOLTAGE +6V (18) full counterclockwise
 CURRENT controls (12), (14), (17) . full counterclockwise
 REFERENCE $\pm 25V$ (6) full counterclockwise
 TRACKING RATIO selector (7) FIXED
 REFERENCE +25 METER selector (3) pushed in

7.2 ADJUSTMENT OF METER ZERO WITH POWER ON

1. +25V range
 - a. Turn the power on.
 - b. Push the REFERENCE +25V METER selector button (3).
 - c. On circuit board T-2665A, adjust VR502 (0 ADJ) until the voltmeter indicates zero.
2. -25V range
 - a. Push the TRACKING -25V METER selector button (4).
 - b. On circuit board T-2665A, adjust VR504 (0 ADJ) until the voltmeter indicates zero.
3. +6V range
 - a. Push the +6V METER selector button (5).
 - b. On circuit board T-2665A, adjust VR506 (0 ADJ) until the voltmeter indicates zero.

7.3 ADJUSTMENT OF THE VOLTMETER WITH POWER ON

1. +25V range

Push the REFERENCE +25V METER selector button (3).

 - a. Connect a known calibrated voltmeter across the +25V output (+) and COM (-) terminals.
 - c. Set the REFERENCE/ \pm 25V control so that the voltmeter reads 25.0Vdc.
 - d. On circuit board T-2665A, adjust VR501 (VOLTS) so that the voltmeter indicates 25V.
2. -25V range
 - a. Push the TRACKING -25V METER selector button (4).
 - b. Connect a known calibrated voltmeter across the -25V output (+) and COM (-) terminals.
 - c. Confirm that the voltmeter and the power supply voltmeter both indicate -25V.
3. +6V range
 - a. Push the +6V METER selector button (5).
 - b. Connect a known calibrated voltmeter across the +6V (+) and COM (-) terminals.
 - c. Use the +6V voltage control to make the voltmeter indicate 6.0Vdc. The power supply voltmeter should indicate 6 volts.

7.4 AMMETER ADJUSTMENTS

1. +0.5A range
 - a. Push the REFERENCE +25V METER selector button.
 - b. Set the +0.5A (1A for the LPS-152) CURRENT control fully clockwise.
 - c. Connect a known calibrated ammeter and a 12.5W (25W for the LPS-152) rheostat as shown in Figure 7-1.
 - d. Set the REFERENCE/ \pm 25V control so that the voltmeter indicates 25V.
 - e. Adjust the rheostat so that the installed ammeter indicates 0.5A (1.0A for the LPS-152).
 - f. On circuit board T-2665A, adjust VR503 (FULL SCALE) for a reading of +0.5A (1.0A for the LPS-152) on the power supply ammeter.
2. -25V range
 - a. Push the TRACKING -25V METER selector button.
 - b. Connect a known calibrated ammeter and a 12.5W (25W for the LPS-152) rheostat as shown in Figure 7-2.
 - c. Set the -0.5A (-1A for the LPS-152) CURRENT control fully clockwise.
 - d. Set the REFERENCE/ \pm 25V control so that the voltmeter indicates -25V.
 - e. Adjust the rheostat so that the installed ammeter indicates -0.5A (-1.0A for the LPS-152).
 - f. On circuit board T-2665A, adjust VR505 (FULL SCALE) for a reading of -0.5A (-1.0A for the LPS-152) on the power supply ammeter.
3. 3A range (5A for the LPS-152)
 - a. Push the +6V METER selector button.
 - b. Connect a known calibrated ammeter and a 18W (30W for the LPS-152) rheostat as shown in Figure 7-3.
 - c. Set the 3A (5A for the LPS-152) CURRENT control fully clockwise.
 - d. Set the REFERENCE/ \pm 25V control so that the voltmeter indicates +6V.
 - e. Adjust the rheostat so that the installed ammeter indicates 3.0A (5.0A for the LPS-152).
 - f. On circuit board T-2665A, adjust VR507 (FULL SCALE) for a reading of 3A (5A for the LPS-152) on the power supply ammeter.

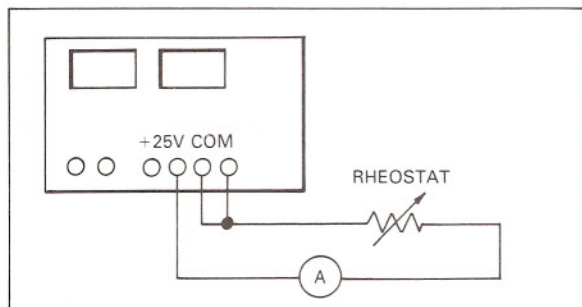

Figure 7-1.

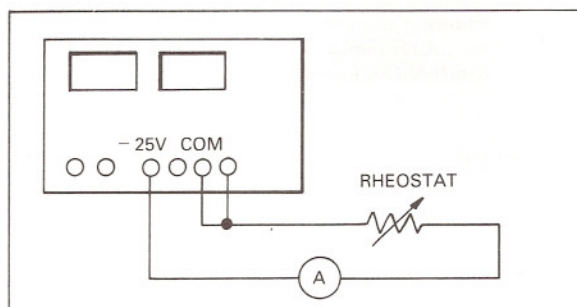

Figure 7-2.

7.5 CONNECTIONS FOR OTHER AC LINE VOLTAGES

The LPS-151/152 units shipped within the U.S. are connected for 120Vac operation. Other line voltages may be used after transformer tap connections are changed. Refer to Figure 7-4 for proper connections, and to Table 7-1 for permissible voltage ranges and proper fuse ratings.

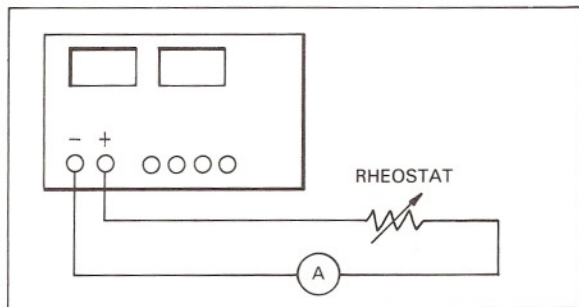

Figure 7-3.

Table 7-1
Permissible Voltage Variations and Fuse Ratings
For Tap Connections

Nominal Value	Operating Voltage Range	Fuse Rating	
		LPS-151	LPS-152
100V	90-110V	2A slow blow	3A slow blow
120V	108-132V		
200V	180-220V	1A slow blow	1.5A slow blow
220V	198-242V		
240V	216-264V		

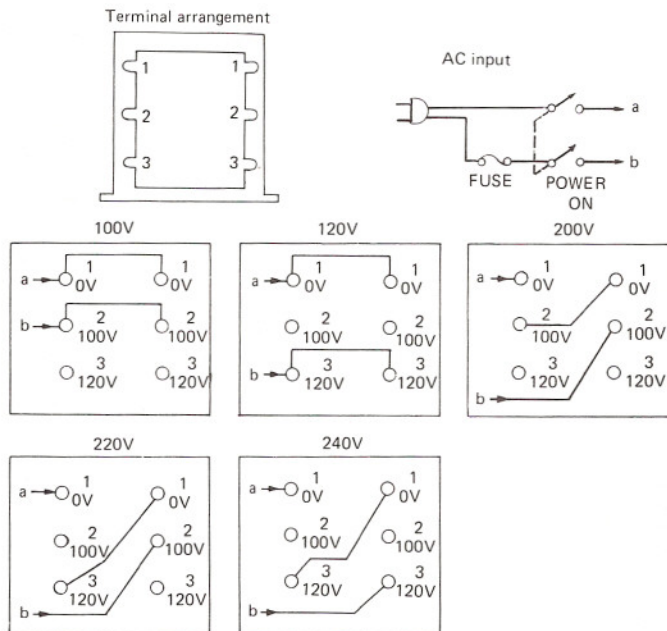

Figure 7-4. Transformer Tap Connections

8. REPLACEMENT PARTS LIST

8.1 LPS-151 Parts List.

SCH. No.	Symbol No.	Description			
DIODES					
1/3	D101	Rect	200V	1A	1DZ61
1/3	D102	Rect	200V	1A	1DZ61
1/3	D103	Zener	7.5V		1Z75
1/3	D104	Det	35V		1S1588
1/3	D105	Det	35V		1S1588
1/3	D106	Det	35V		1S1588
1/3	D107	Zener	6.2V		1SZ51
1/3	D108	Zener	9.1V		RD91EB
1/3	D109	Rect	200V	1A	1DZ61
1/3	D201	Rect	150V	3A	3CD13
1/3	D202	Rect	150V	3A	3CD13
1/3	D203	Rect	100V	3A	3BZ61
1/3	D204	Det	35V		1S1588
1/3	D205	Det	35V		1S1588
1/3	D206	Det	35V		1S1588
1/3	D207	Det	35V		1S1588
1/3	D208	Det	35V		1S1588
1/3	D209	Det	35V		1S1588
1/3	D210	Rect	200V	1A	1DZ61
1/3	D301	Rect	200V	1A	1DZ61
1/3	D302	Rect	200V	1A	1DZ61
1/3	D303	Rect	200V	1A	1DZ61
1/3	D304	Det	35V		1S1588
1/3	D305	Det	35V		1S1588
1/3	D306	Det	35V		1S1588
1/3	D307	Det	35V		1S1588
1/3	D308	Det	35V		1S1588
1/3	D309	Det	35V		1S1588
1/3	D310	Rect	200V	1A	1DZ61
1/3	D401	Rect	200V	1A	1DZ61
1/3	D402	Rect	200V	1A	1DZ61
1/3	D403	Rect	200V	1A	1DZ61
1/3	D404	Rect	200V	1A	1DZ61
1/3	D405	Det	35V		1S1588
1/3	D406	Det	35V		1S1588
1/3	D407	Det	35V		1S1588
1/3	D408	Det	35V		1S1588
1/3	D409	Rect	200V	1A	1DZ61
1/3	D410	Det	35V		1S1588
2/3	D501	Det	35V		1S1588
1/3	PL101	LED			SLP-751
ICs					
1/3	IC101	Op Amp	LM301AP		
1/3	IC201	Op Amp	1458		
1/3	IC301	Op Amp	1458		
1/3	IC401	Op Amp	1458		
TRANSISTORS					
1/3	Q101	NPN	2SC495-0		
1/3	Q102	PNP	2SA1012		
1/3	Q103	NPN	2SC1815-0		
1/3	Q104	NPN	2SC495-0		
1/3	Q105	PNP	2SA505-0		

SCH. No.	Symbol No.	Description			
TRANSISTORS					
1/3	Q201	NPN	2SD717-0		
1/3	Q202	PNP	2SB755-0		
1/3	Q301	NPN	2SC495-0		
1/3	Q302	PNP	2SB755-0		
1/3	Q401	NPN	2SD845-0		
1/3	Q402	PNP	2SA505-0		
CAPACITORS					
1/3	C101	Electrolytic	100V	1000 μ F	
1/3	C102	Mica	500V	330pF	$\pm 10\%$
1/3	C103	Electrolytic	50V	0.47 μ F	$\pm 20\%$
1/3	C201	Plastic	400V	0.047 μ F	$\pm 10\%$
1/3	C202	Plastic	400V	0.047 μ F	$\pm 10\%$
1/3	C203	Electrolytic	25V	10,000 μ F	
1/3	C204	Plastic	50V	0.01 μ F	$\pm 10\%$
1/3	C205	Plastic	50V	0.0047 μ F	$\pm 10\%$
1/3	C206	Electrolytic	50V	10 μ F	
1/3	C207	Electrolytic	16V	1,000 μ F	
1/3	C208	Plastic	63V	1 μ F	$\pm 10\%$
1/3	C301	Plastic	400V	0.047 μ F	$\pm 10\%$
1/3	C302	Plastic	400V	0.047 μ F	$\pm 10\%$
1/3	C303	Electrolytic	63V	2200 μ F	
1/3	C304	Plastic	50V	0.0022 μ F	$\pm 10\%$
1/3	C305	Plastic	50V	0.0022 μ F	$\pm 10\%$
1/3	C306	Electrolytic	50V	10 μ F	
1/3	C307	Electrolytic	50V	220 μ F	
1/3	C308	Ceramic	50V	0.1 μ F	
1/3	C309	Plastic	50V	0.0033 μ F	$\pm 10\%$
1/3	C401	Plastic	400V	0.047 μ F	$\pm 10\%$
1/3	C402	Plastic	400V	0.047 μ F	$\pm 10\%$
1/3	C403	Electrolytic	63V	2200 μ F	
1/3	C404	Plastic	50V	0.01 μ F	$\pm 10\%$
1/3	C405	Plastic	50V	0.0033 μ F	$\pm 10\%$
1/3	C406	Electrolytic	50V	10 μ F	
1/3	C407	Electrolytic	50V	220 μ F	
1/3	C408	Ceramic	50V	0.1 μ F	
RESISTORS					
1/3	R101	Wire wound	31 Ω	$\pm 5\%$	5W
1/3	R102	Wire wound	130 Ω	$\pm 5\%$	3W
1/3	R103	Wire wound	250 Ω	$\pm 5\%$	3W
1/3	R104	Wire wound	100 Ω	$\pm 5\%$	10W
1/3	R105	Metal	880 Ω	$\pm 1\%$	1/4W
1/3	R106	Metal	10k Ω	$\pm 1\%$	1/4W
1/3	R107	Metal	10k Ω	$\pm 1\%$	1/4W
1/3	R108	Carbon	15k Ω	$\pm 5\%$	1/4W
1/3	R109	Carbon	220 Ω	$\pm 5\%$	1/2W
1/3	R110	Carbon	10k Ω	$\pm 5\%$	1/4W
1/3	R111	Carbon	3.3k Ω	$\pm 5\%$	1/4W
1/3	R112	Carbon	10k Ω	$\pm 5\%$	1/4W
1/3	R113	Carbon	15k Ω	$\pm 5\%$	1/4W
1/3	R114	Carbon	1.2k Ω	$\pm 5\%$	1/4W

SCH. No.	Symbol No.	Description			
RESISTORS					
1/3	R201	Carbon	2.2kΩ	±5%	½W
1/3	R202	Wire wound	50Ω	±5%	10W
1/3	R203	Carbon	820Ω	±5%	½W
1/3	R204				
1/3	R205				
1/3	R206	Carbon	7.5kΩ	±5%	½W
1/3	R207	Metal	150kΩ	±1%	¼W
1/3	R208	Metal	100Ω	±1%	¼W
1/3	R209	Carbon	750Ω	±5%	¼W
1/3	R210	Wire wound	0.25Ω	±5%	5W
1/3	R211	Carbon	220Ω	±5%	¼W
1/3	R212	Metal	39kΩ	±1%	¼W
1/3	R213	Carbon	330Ω	±5%	¼W
1/3	R214	Carbon	18Ω	±5%	½W
1/3	R215	Metal	9.1kΩ	±1%	¼W
1/3	R216	Wire wound	0.1Ω	±5%	2W
1/3	R301	Carbon	5.6kΩ	±5%	½W
1/3	R302	Metal	560Ω	±5%	1W
1/3	R303	Carbon	820Ω	±5%	½W
1/3	R304	Carbon	15kΩ	±5%	½W
1/3	R305	Metal	100kΩ	±1%	¼W
1/3	R306	Metal	560Ω	±1%	¼W
1/3	R307	Metal	5.6kΩ	±1%	¼W
1/3	R308	Wire wound	1.5Ω	±5%	5W
1/3	R309	Carbon	220Ω	±5%	¼W
1/3	R310	Metal	3.9kΩ	±1%	¼W
1/3	R311	Carbon	1.5kΩ	±5%	¼W
1/3	R312	Carbon	18Ω	±5%	½W
1/3	R313	Metal	2.2kΩ	±1%	¼W
1/3	R314	Wire wound	0.1Ω	±5%	2W
1/3	R401	Carbon	5.6kΩ	±5%	½W
1/3	R402	Carbon	820Ω	±5%	½W
1/3	R403	Carbon	560Ω	±5%	½W
1/3	R404	Carbon	15kΩ	±5%	¼W
1/3	R405	Metal	560Ω	±1%	¼W
1/3	R406	Carbon	1.5kΩ	±5%	¼W
1/3	R407	Carbon	18Ω	±5%	½W
1/3	R408	Carbon	220Ω	±5%	¼W
1/3	R409	Wire wound	1.5Ω	±5%	5W
1/3	R410	Metal	3.9kΩ	±1%	¼W
1/3	R411	Metal	22kΩ	±1%	¼W
1/3	R412	Metal	10kΩ	±1%	¼W
1/3	R413	Metal	22kΩ	±1%	¼W
1/3	R414				
1/3	R415	Wire wound	0.1Ω	±5%	2W
2/3	R501	Carbon	390Ω	±5%	¼W
2/3	R502	Carbon	470Ω	±5%	¼W
2/3	R503	Metal	12kΩ	±1%	¼W
2/3	R504	Metal	200Ω	±1%	¼W
2/3	R505	Metal	2.4kΩ	±1%	¼W
2/3	R506	Carbon	100kΩ	±5%	¼W
2/3	R507	Carbon	56kΩ	±5%	¼W
2/3	R508	Carbon	68kΩ	±5%	¼W
VARIABLE RESISTORS					
1/3	VR201	Wire wound	10kΩB	±5%	1.2W
1/3	VR202	Wire wound	3kΩB	±5%	1.2W
1/3	VR301	Wire wound	10kΩB	±5%	1.2W
1/3	VR302	Wire wound	3kΩB	±5%	1.2W

SCH. No.	Symbol No.	Description			
VARIABLE RESISTORS					
1/3	VR401	Wire wound	3kΩB	±5%	1.2W
1/3	VR402	Wire wound	10kΩB	±5%	1.2W
2/3	VR501	Metal glaze	220Ω		½W
2/3	VR502	Metal glaze	1kΩ		½W
2/3	VR503	Metal glaze	1kΩ		½W
2/3	VR504	Metal glaze	1kΩ		½W
2/3	VR505	Metal glaze	1kΩ		½W
2/3	VR506	Metal glaze	1kΩ		½W
2/3	VR507	Metal glaze	1kΩ		½W
TRANSFORMER					
1/3	PT101	Power Transformer	J-459A		
CONNECTORS					
1/3	J101	XH Connector	{B2B-XH XHP-2		
1/3	J201	XH Connector	{B2B-XH XHP-2		
1/3	J202	XH Connector	{B3B-XH XHP-3		
1/3	J301	XH Connector	{B2B-XH XHP-2		
1/3	J302	XH Connector	{B3B-XH XHP-3		
1/3	J401	XH Connector	{B3B-XH XHP-3		
1/3	J402	XH Connector	{B3B-XH XHP-3		
3/3	J403	XH Connector	{B9B-XH XHP-9		
1/3	J501	XH Connector	{B2B-XH XHP-2		
1/3	J502	XH Connector	{B2B-XH XHP-2		
FUSE & HOLDER					
1/3	F501	90 — 132V	ST-4 2A		
	F501	Holder	FH-032		
		180 — 264V	ST-4 1A		
METERS					
2/3	M501		H-1690		
2/3	M502		H-1691		
SWITCHES					
1/3	S401	Slide	SSB022L=9		
1/3	S501	Power	SDGSP-E		
2/3	S502	Push	S-3-14		
TERMINALS					
1/3	101	Metal Terminal	D-1376A		
1/3	201	Leader Terminal	Gray		
1/3	202	Leader Terminal	Gray		
1/3	301	Leader Terminal	Gray		
1/3	302	Leader Terminal	Gray		
1/3	401	Leader Terminal	Gray		
PRINTED CIRCUIT BOARDS					
1/3		T-2672B	Power Supply		
2/3		T-2665A	Meter		

8.2 LPS-152 Parts List.

SCH. No.	Symbol No.	Description			
DIODES					
1/3	D101	Rect	200V	1A	1DZ61
1/3	D102	Rect	200V	1A	1DZ61
1/3	D103	Zener	7.5V		1Z75
1/3	D104	Det	35V		1S1588
1/3	D105	Det	35V		1S1588
1/3	D106	Det	35V		1S1588
1/3	D107	Zener	6.2V		1SZ51
1/3	D108	Zener	9.1V		RD91EB
1/3	D109	Rect	200V	1A	1DZ61
1/3	D201	Rect	150V	6A	6CD13
1/3	D202	Rect	150V	6A	6CD13
1/3	D203	Rect	100V	3A	3BZ61
1/3	D204	Det	35V		1S1588
1/3	D205	Det	35V		1S1588
1/3	D206	Det	35V		1S1588
1/3	D207	Det	35V		1S1588
1/3	D208	Det	35V		1S1588
1/3	D209	Det	35V		1S1588
1/3	D210	Rect	100V	3A	3BZ61
1/3	D301	Rect	200V	1A	1DZ61
1/3	D302	Rect	200V	1A	1DZ61
1/3	D303	Rect	200V	1A	1DZ61
1/3	D304	Det	35V		1S1588
1/3	D305	Det	35V		1S1588
1/3	D306	Det	35V		1S1588
1/3	D307	Det	35V		1S1588
1/3	D308	Det	35V		1S1588
1/3	D309	Det	35V		1S1588
1/3	D310	Rect	200V	1A	1DZ61
1/3	D401	Rect	200V	1A	1DZ61
1/3	D402	Rect	200V	1A	1DZ61
1/3	D403	Rect	200V	1A	1DZ61
1/3	D404	Rect	200V	1A	1DZ61
1/3	D405	Det	35V		1S1588
1/3	D406	Det	35V		1S1588
1/3	D407	Det	35V		1S1588
1/3	D408	Det	35V		1S1588
1/3	D409	Rect	200V	1A	1DZ61
1/3	D410	Det	35V		1S1588
2/3	D501	Det	35V		1S1588
1/3	PL101	LED			SLP-751
ICs					
1/3	IC101	Op Amp	LM301AP		
1/3	IC201	Op Amp	1458		
1/3	IC301	Op Amp	1458		
1/3	IC401	Op Amp	1458		
TRANSISTORS					
1/3	Q101	NPN	2SC495-0		
1/3	Q102	PNP	2SA1012		
1/3	Q103	NPN	2SC1815-0		
1/3	Q104	NPN	2SC495-0		
1/3	Q105	PNP	2SA505-0		
1/3	Q201	NPN	2SD717-0		
1/3	Q202	PNP	2SB755-0		
1/3	Q203	PNP	2SB755-0		

SCH. No.	Symbol No.	Description			
1/3	Q301	NPN	2SC495-0		
1/3	Q302	PNP	2SB755-0		
1/3	Q401	NPN	2SD845-0		
1/3	Q402	PNP	2SA505-0		
CAPACITORS					
1/3	C101	Electrolytic	100V	1000 μ F	
1/3	C102	Mica	500V	330pF	$\pm 10\%$
1/3	C103	Electrolytic	50V	0.47 μ F	$\pm 20\%$
1/3	C201	Plastic	400V	0.047 μ F	$\pm 10\%$
1/3	C202	Plastic	400V	0.047 μ F	$\pm 10\%$
1/3	C203	Electrolytic	25V	10,000 μ F	
1/3	C204	Plastic	50V	0.01 μ F	$\pm 10\%$
1/3	C205	Plastic	50V	0.0047 μ F	$\pm 10\%$
1/3	C206	Electrolytic	50V	10 μ F	
1/3	C207	Electrolytic	16V	1,000 μ F	
1/3	C208	Plastic	63V	1 μ F	$\pm 10\%$
1/3	C301	Plastic	400V	0.047 μ F	$\pm 10\%$
1/3	C302	Plastic	400V	0.047 μ F	$\pm 10\%$
1/3	C303	Electrolytic	63V	2200 μ F	
1/3	C304	Plastic	50V	0.0022 μ F	$\pm 10\%$
1/3	C305	Plastic	50V	0.0022 μ F	$\pm 10\%$
1/3	C306	Electrolytic	50V	10 μ F	
1/3	C307	Electrolytic	50V	220 μ F	
1/3	C308	Ceramic	50V	0.1 μ F	
1/3	C309	Plastic	50V	0.0033 μ F	$\pm 10\%$
1/3	C401	Plastic	400V	0.047 μ F	$\pm 10\%$
1/3	C402	Plastic	400V	0.047 μ F	$\pm 10\%$
1/3	C403	Electrolytic	63V	2200 μ F	
1/3	C404	Plastic	50V	0.01 μ F	$\pm 10\%$
1/3	C405	Plastic	50V	0.0033 μ F	$\pm 10\%$
1/3	C406	Electrolytic	50V	10 μ F	
1/3	C407	Electrolytic	50V	220 μ F	
1/3	C408	Ceramic	50V	0.1 μ F	
RESISTORS					
1/3	R101	Wire wound	31 Ω	$\pm 5\%$	5W
1/3	R102	Wire wound	130 Ω	$\pm 5\%$	3W
1/3	R103	Wire wound	250 Ω	$\pm 5\%$	3W
1/3	R104	Wire wound	100 Ω	$\pm 5\%$	10W
1/3	R105	Metal	880 Ω	$\pm 1\%$	1/4W
1/3	R106	Metal	10k Ω	$\pm 1\%$	1/4W
1/3	R107	Metal	10k Ω	$\pm 1\%$	1/4W
1/3	R108	Carbon	15k Ω	$\pm 5\%$	1/4W
1/3	R109	Carbon	220 Ω	$\pm 5\%$	1/2W
1/3	R110	Carbon	10k Ω	$\pm 5\%$	1/4W
1/3	R111	Carbon	3.3k Ω	$\pm 5\%$	1/4W
1/3	R112	Carbon	10k Ω	$\pm 5\%$	1/4W
1/3	R113	Carbon	15k Ω	$\pm 5\%$	1/4W
1/3	R114	Carbon	1.2k Ω	$\pm 5\%$	1/4W
1/3	R201	Carbon	2.2k Ω	$\pm 5\%$	1/2W
1/3	R202	Wire wound	50 Ω	$\pm 5\%$	10W
1/3	R203	Carbon	820 Ω	$\pm 5\%$	1/2W
1/3	R204	Wire wound	0.1 Ω	$\pm 5\%$	2W
1/3	R205	Wire wound	0.1 Ω	$\pm 5\%$	2W
1/3	R206	Carbon	7.5k Ω	$\pm 5\%$	1/2W
1/3	R207	Metal	150k Ω	$\pm 1\%$	1/4W
1/3	R208	Metal	100 Ω	$\pm 1\%$	1/4W

SCH. No.	Symbol No.	Description		
RESISTORS				
1/3	R209	Carbon	750Ω ±5%	¼W
1/3	R210	Wire wound	0.25Ω ±5%	5W
1/3	R211	Carbon	220Ω ±5%	¼W
1/3	R212	Metal	39kΩ ±1%	¼W
1/3	R213	Carbon	330Ω ±5%	¼W
1/3	R214	Carbon	18Ω ±5%	½W
1/3	R215	Metal	9.1kΩ ±1%	¼W
1/3	R216	Wire wound	0.1Ω ±5%	2W
1/3	R301	Carbon	5.6kΩ ±5%	½W
1/3	R302	Metal	560Ω ±5%	1W
1/3	R303	Carbon	820Ω ±5%	½W
1/3	R304	Carbon	15kΩ ±5%	½W
1/3	R305	Metal	100kΩ ±1%	¼W
1/3	R306	Metal	560Ω ±1%	¼W
1/3	R307	Metal	5.6kΩ ±1%	¼W
1/3	R308	Wire wound	0.5Ω ±5%	5W
1/3	R309	Carbon	150Ω ±5%	¼W
1/3	R310	Metal	39kΩ ±1%	¼W
1/3	R311	Carbon	1.5kΩ ±5%	¼W
1/3	R312	Carbon	18Ω ±5%	½W
1/3	R313	Metal	2.2kΩ ±1%	¼W
1/3	R314	Wire wound	0.1Ω ±5%	2W
1/3	R401	Carbon	5.6kΩ ±5%	½W
1/3	R402	Carbon	820Ω ±5%	½W
1/3	R403	Carbon	560Ω ±5%	½W
1/3	R404	Carbon	15kΩ ±5%	¼W
1/3	R405	Metal	560Ω ±1%	¼W
1/3	R406	Carbon	1.5kΩ ±5%	¼W
1/3	R407	Carbon	18Ω ±5%	½W
1/3	R408	Carbon	150Ω ±5%	¼W
1/3	R409	Wire wound	0.5Ω ±5%	5W
1/3	R410	Metal	39kΩ ±1%	¼W
1/3	R411	Metal	22kΩ ±1%	¼W
1/3	R412	Metal	10kΩ ±1%	¼W
1/3	R413	Metal	22kΩ ±1%	¼W
1/3	R414			
1/3	R415	Wire wound	0.1Ω ±5%	2W
2/3	R501	Carbon	390Ω ±5%	¼W
2/3	R502	Carbon	470Ω ±5%	¼W
2/3	R503	Metal	12kΩ ±1%	¼W
2/3	R504	Metal	200Ω ±1%	¼W
2/3	R505	Metal	2.4kΩ ±1%	¼W
2/3	R506	Carbon	100kΩ ±5%	¼W
2/3	R507	Carbon	56kΩ ±5%	¼W
2/3	R508	Carbon	68kΩ ±5%	¼W
VARIABLE RESISTORS				
1/3	VR201	Wire wound	10kΩB ±5%	1.2W
1/3	VR202	Wire wound	3kΩB ±5%	1.2W
1/3	VR301	Wire wound	10kΩB ±5%	1.2W
1/3	VR302	Wire wound	3kΩB ±5%	1.2W
1/3	VR401	Wire wound	3kΩB ±5%	1.2W
1/3	VR402	Wire wound	10kΩB ±5%	1.2W
2/3	VR501	Metal glaze	220Ω	½W
2/3	VR502	Metal glaze	1kΩ	½W

SCH. No.	Symbol No.	Description		
VARIABLE RESISTORS				
2/3	VR503	Metal glaze	1kΩ	½W
2/3	VR504	Metal glaze	1kΩ	½W
2/3	VR505	Metal glaze	1kΩ	½W
2/3	VR506	Metal glaze	1kΩ	½W
2/3	VR507	Metal glaze	1kΩ	½W
TRANSFORMER				
1/3	PT101	Power Transformer	J-460A	
CONNECTORS				
1/3	J101	XH Connector	{B2B-XH XHP-2	
1/3	J201	XH Connector	{B2B-XH XHP-2	
1/3	J202	XH Connector	{B3B-XH XHP-3	
1/3	J301	XH Connector	{B2B-XH XHP-2	
1/3	J302	XH Connector	{B3B-XH XHP-3	
1/3	J401	XH Connector	{B3B-XH XHP-3	
1/3	J402	XH Connector	{B3B-XH XHP-3	
3/3	J403	XH Connector	{B9B-XH XHP-9	
1/3	J501	XH Connector	{B2B-XH XHP-2	
1/3	J502	XH Connector	{B2B-XH XHP-2	
FUSE & HOLDER				
1/3	F501	90 — 132V 180 — 264V Holder	ST-4 ST-4 FH-032	3A 1.5A
METERS				
2/3	M501			H-1692
2/3	M502			H-1691
SWITCHES				
1/3	S401	Slide		SSB022 L=9
1/3	S501	Power		SDG5P-E
2/3	S502	Push		S-3-14
TERMINALS				
1/3	101	Metal Terminal		D-1376A
1/3	201	Leader Terminal		Gray
1/3	202	Leader Terminal		Gray
1/3	301	Leader Terminal		Gray
1/3	302	Leader Terminal		Gray
1/3	401	Leader Terminal		Gray
PRINTED CIRCUIT BOARDS				
1/3		T-2672B		Power Supply
2/3		T-2665A		Meter

9. BLOCK DIAGRAM, P.C. BOARDS, AND SCHEMATICS

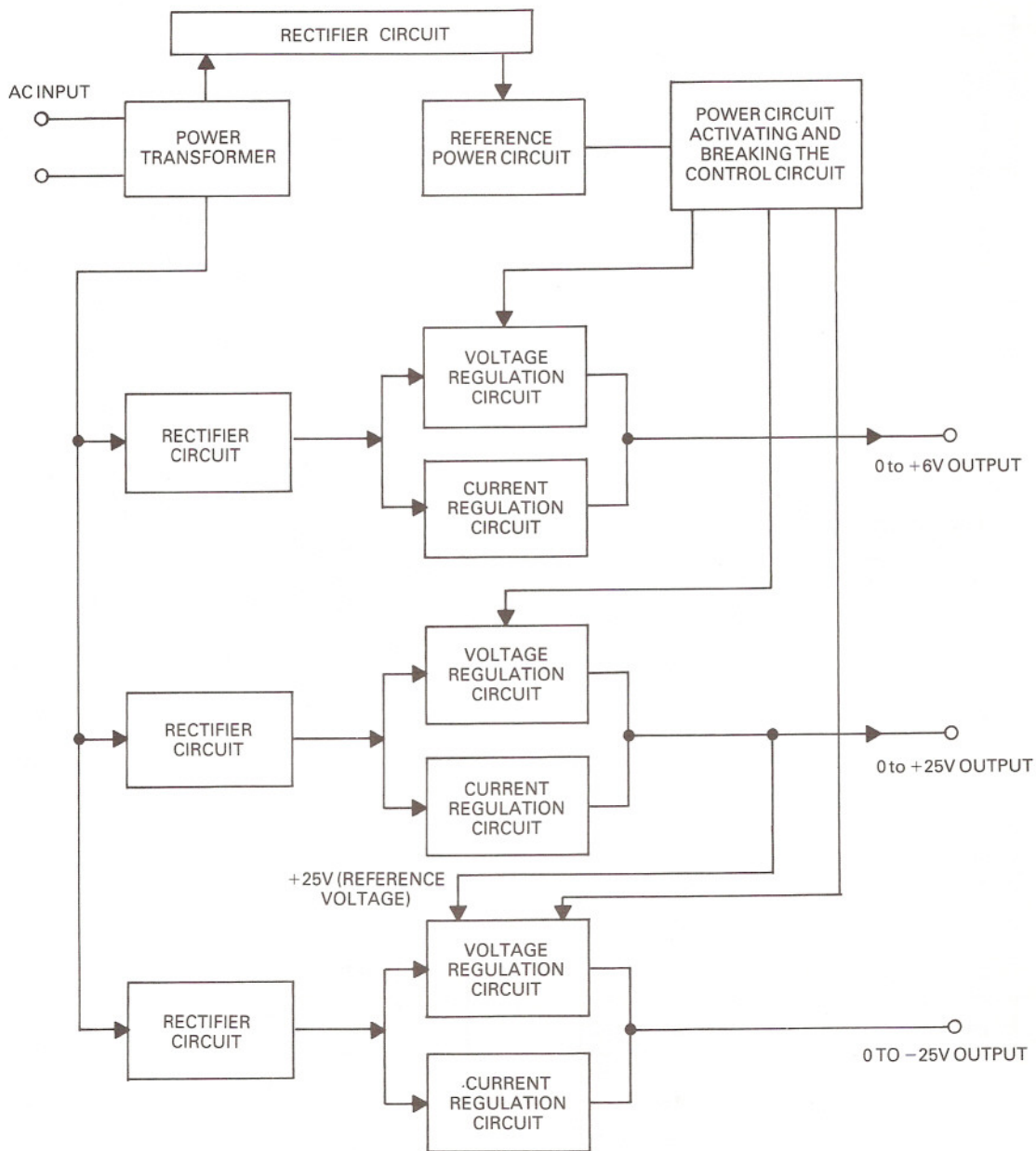
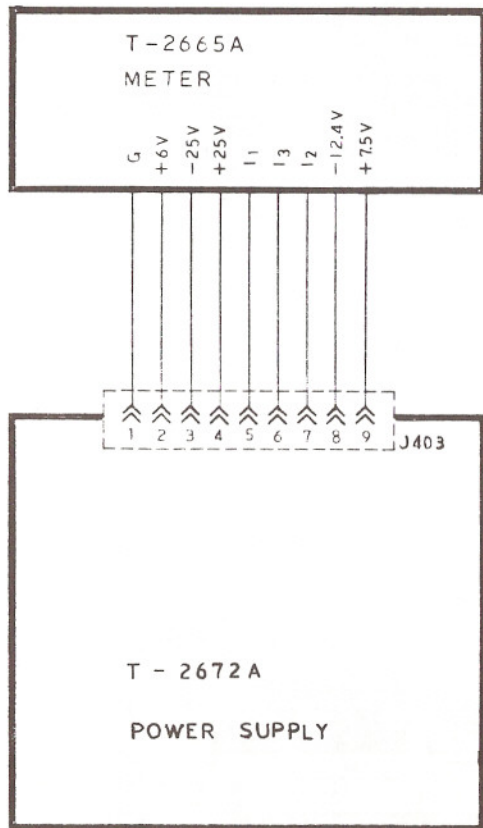

Figure 9-1. Block Diagram



13

Figure 9-2. LPS-151/152 Block Diagram

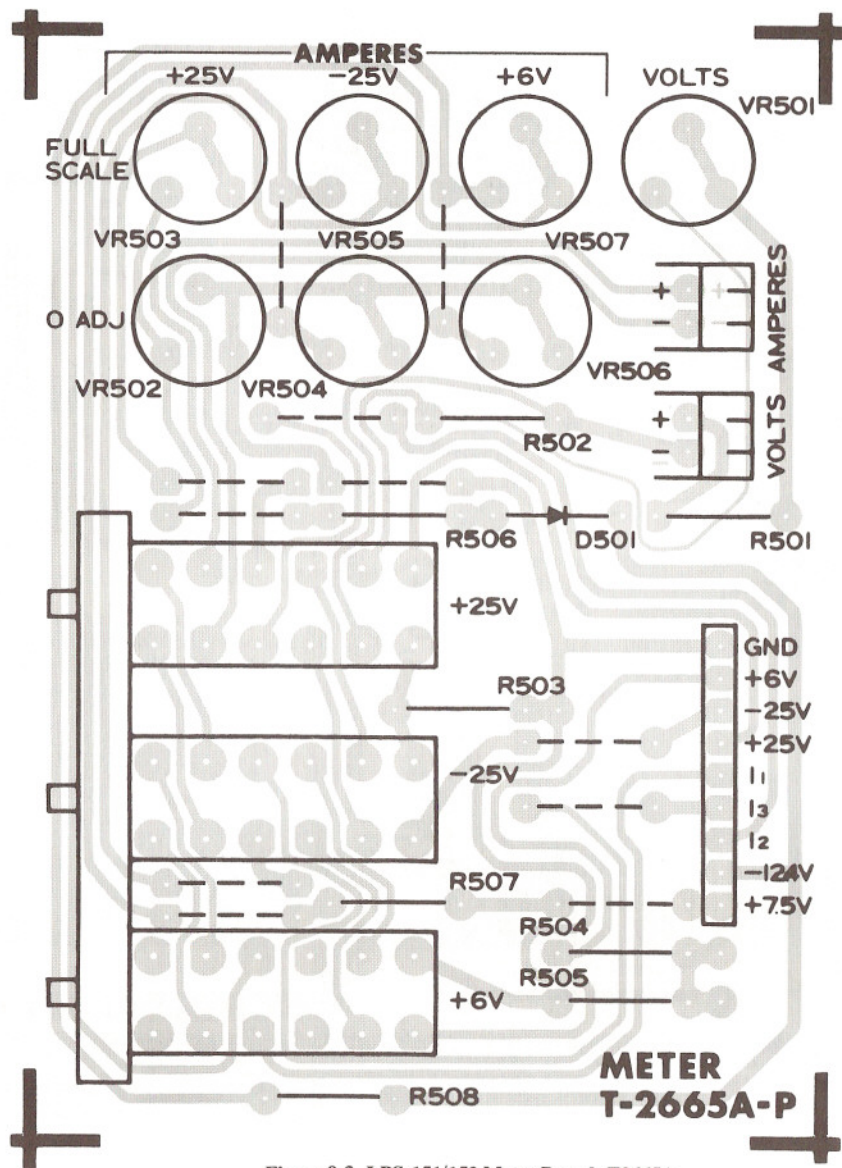

Figure 9-3. LPS-151/152 Meter Board, T2665A

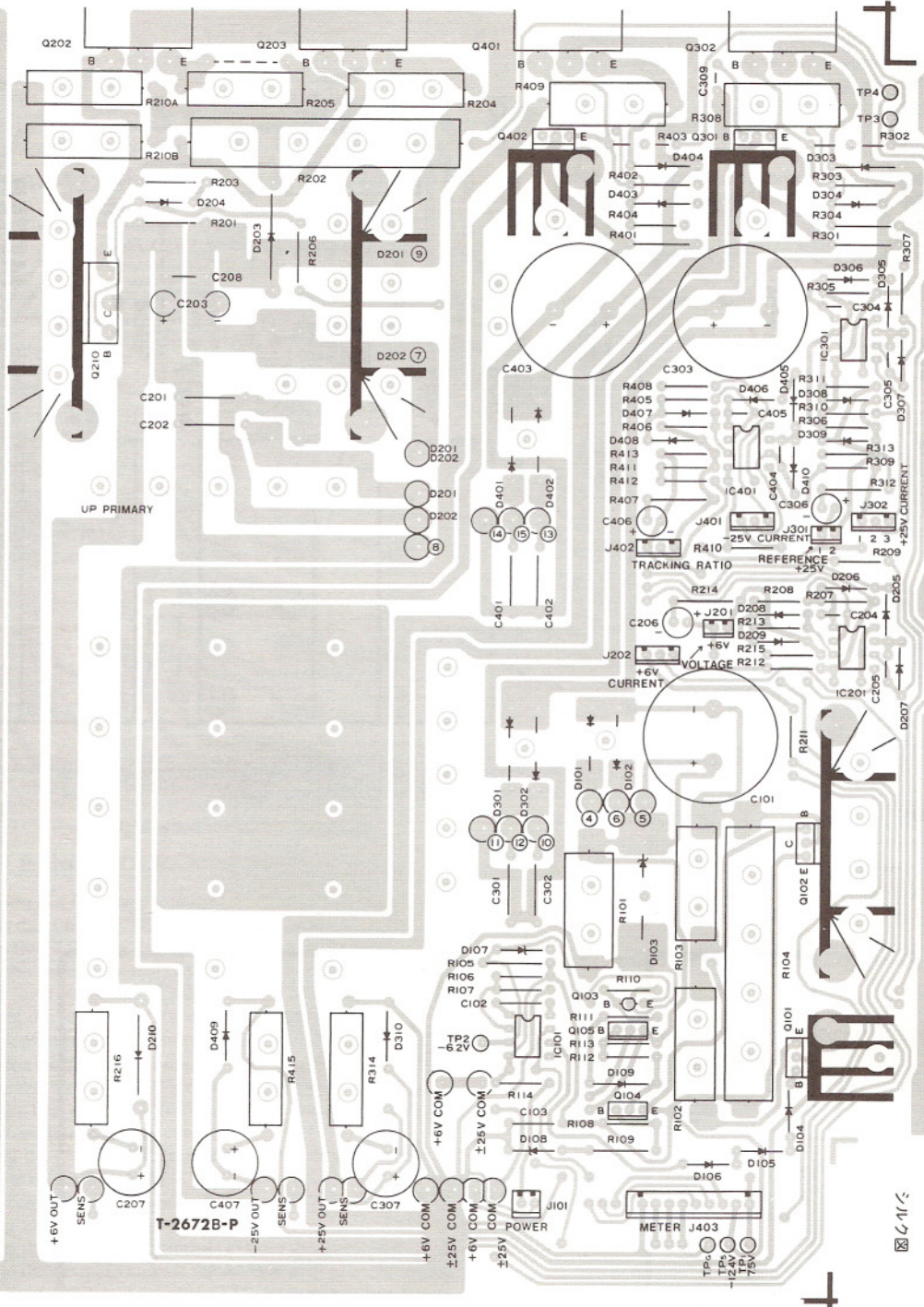

Figure 9-4. LPS-151/152 Power Supply Board, T2672A

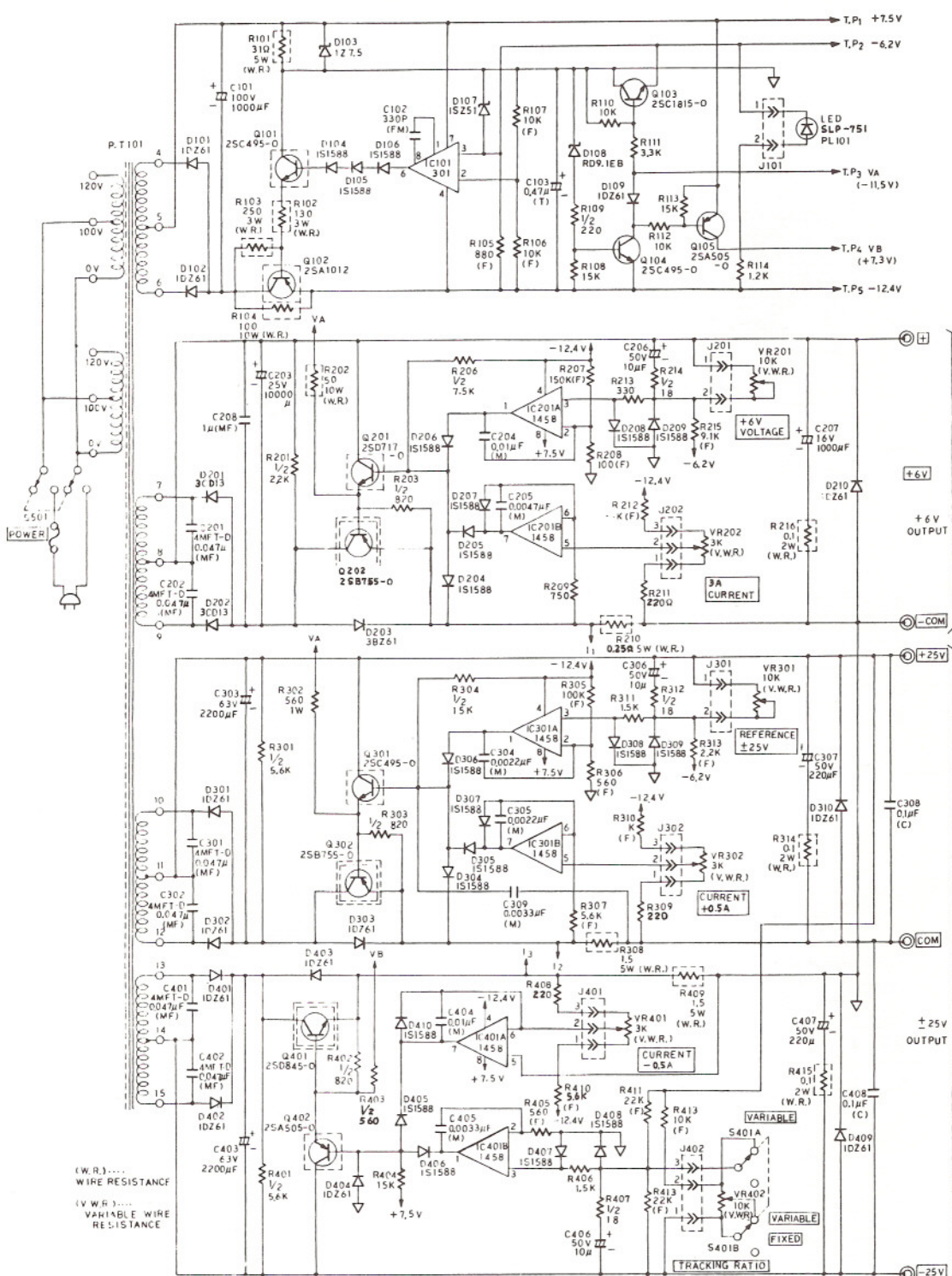

Figure 9-5. LPS-151 Power Supply Board, T2672A

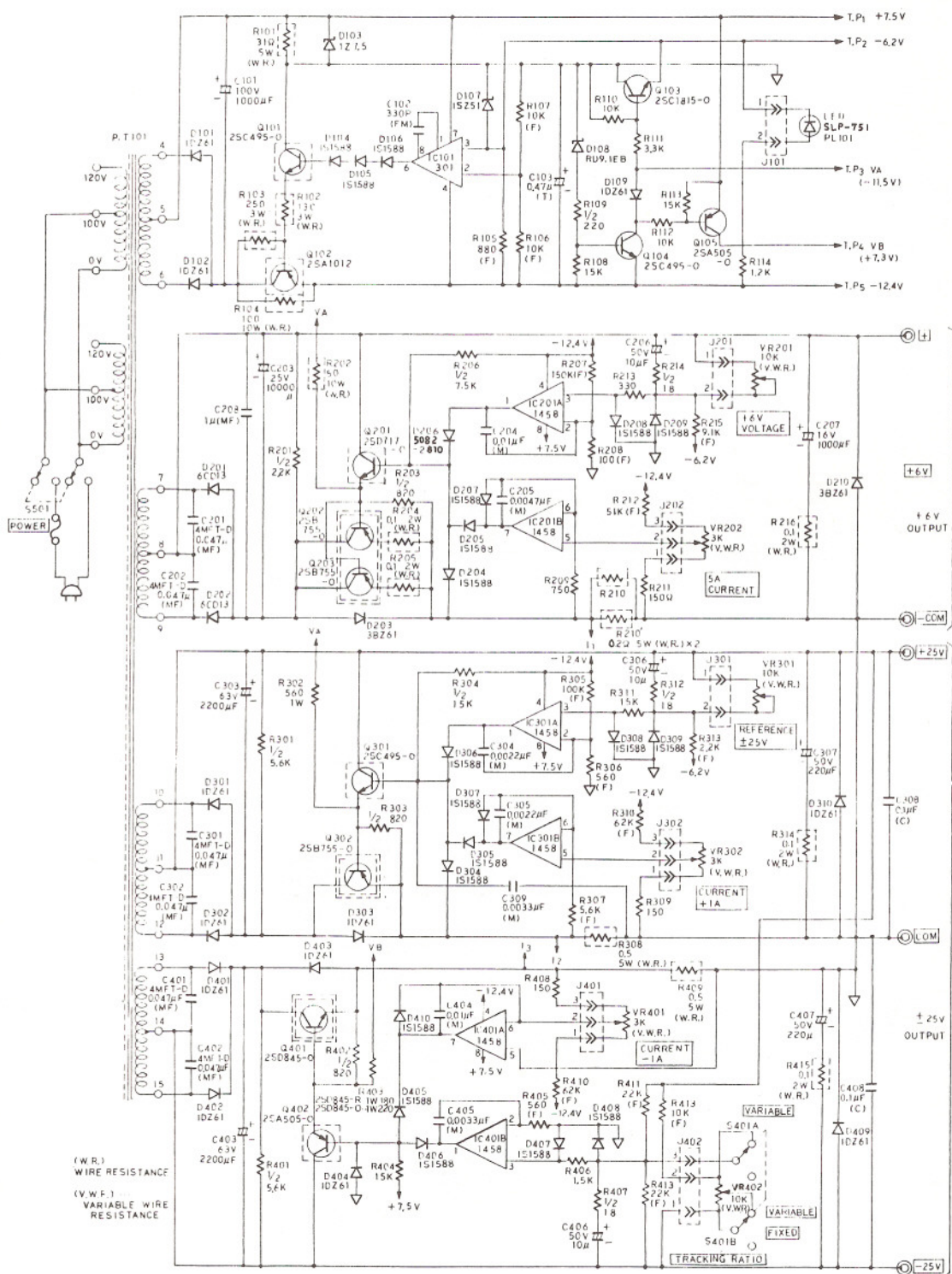

Figure 9-6. LPS-152 Power Supply Board, T2672A

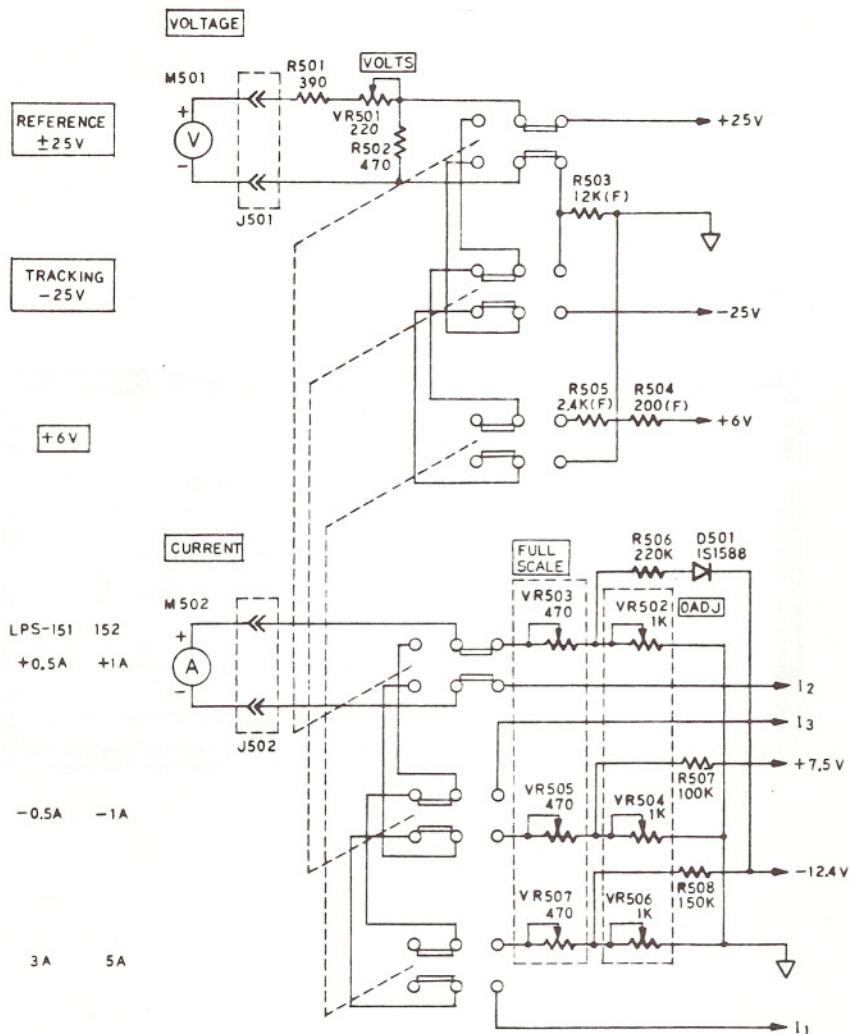

Figure 9-7 LPS-151/152 Meter Board, T2665A

EVERYTHING 4 LESS



ENJOY YOUR BOOKS



PLEASE VISIT OUR STORE FOR EVEN MORE GREAT STUFF!

WWW.EVERYTHING4LESSSTORE.COM

COPYRIGHT NOTICE

ALL MATERIALS INCLUDING CD/DVD AND PDF FILES ARE COPYRIGHTED

WWW.EVERYTHING4LESSSTORE.COM VON WALTHOUR PRODUCTIONS AND MAY NOT BE REPRODUCED, COPIED OR RESOLD UNDER ANY CIRCUMSTANCES. YOU MAY HOWEVER MAKE A COPY FOR YOUR OWN PERSONAL BACKUP. MATERIALS ARE FOR PERSONAL USE ONLY.

IF YOU PURCHASED THIS FROM ANYWHERE BUT FROM US PLEASE NOTIFY US IMMEDIATELY SO THAT WE MAY CHECK IF YOU PURCHASED FROM AN AUTHORIZED RESELLER SO WE CAN LET YOU KNOW IF YOU NEED TO RETURN FOR FULL REFUND FROM AN UNAUTHORIZED SELLER.

THANKS AGAIN AND PLEASE TAKE THE TIME TO VISIT OUR STORE.

ATTENTION! EVERYTHING ON SALE NOW!!



HOT SALE!

**THIS PAGE COPYRIGHT VON WALTHOUR PRODUCTIONS
WWW.EVERYTHING4LESSSTORE.COM**